



IT'S AS EASY AS PLACE, PLUG, GO!

The Connectrac GO system gives you power, telephone, and computer connectivity anywhere, anytime, and within minutes. Simply place the durable, anodized aluminum wireway on top of any floor surface and plug the cord into a handy outlet. Locate the receptacle unit where you need it, install up to 4 CAT 6 cables and you're all set. GO gives you the flexibility to provide, move or change connectivity when needed. Feel the freedom of Connectrac GO.

- Durable anodized architectural aluminum
- Available in 6' and 12' lengths
- Provides two electrical outlets
- Provides up to 4 telecom ports
- Perfect for lecterns, conference tables, desks and more

Patent Pending

GO WIREWAY

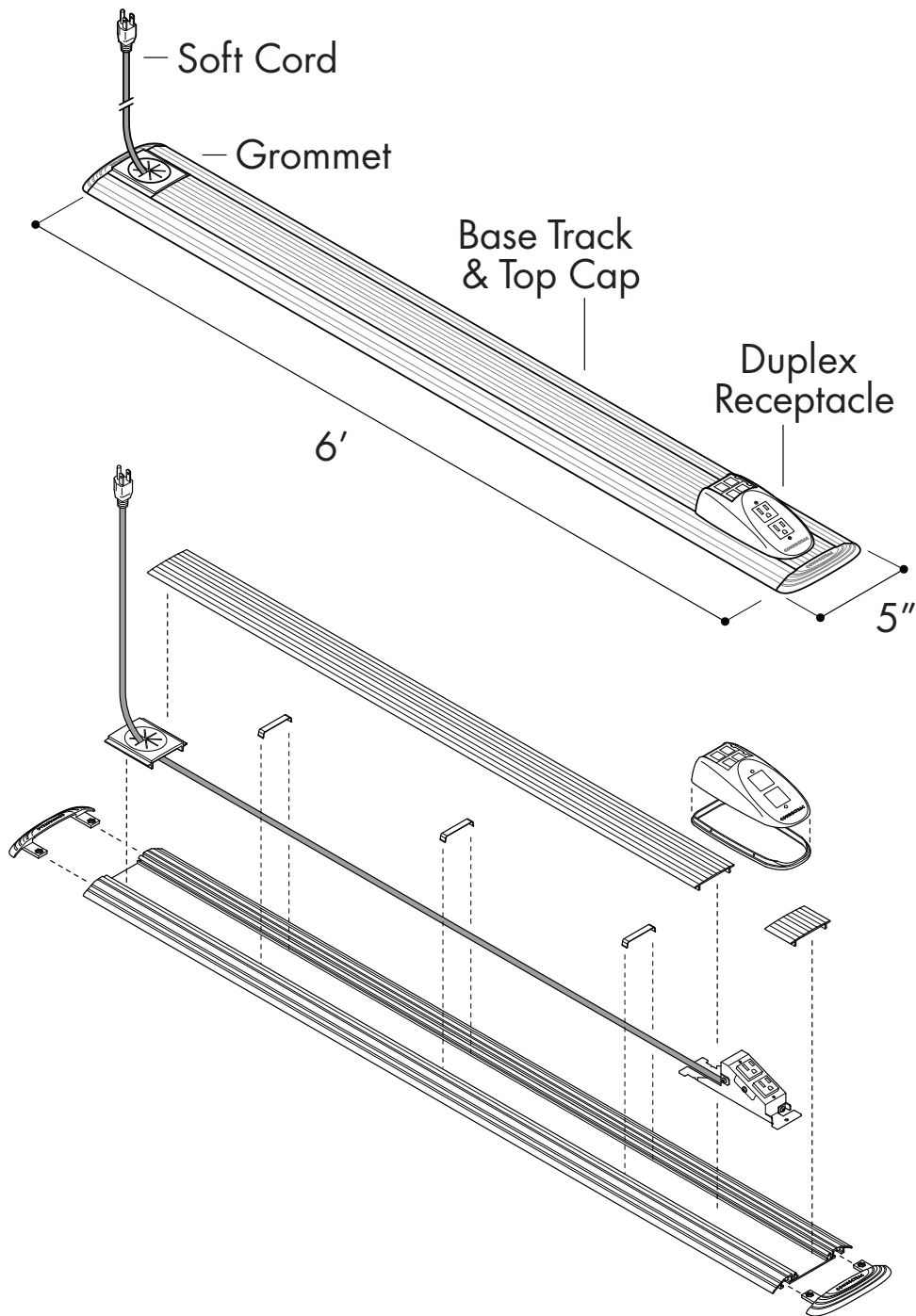

PART NUMBER:	DESCRIPTION:	PRICE
GO-072	Connectrac GO 72" kit w/ Clear Anodized finish, 108" flexible cord w/ plug & 15A duplex receptacle	\$469.00 USD (CA)
GO-144	Connectrac GO 144" kit w/ Clear Anodized finish, 168" flexible cord w/ plug & 15A duplex receptacle	\$701.00 USD (CA)

CONNECTRAC LIMITED WARRANTY

Strong Products Group, Ltd. d/b/a Connectrac ("Connectrac") hereby warrants, to the original purchaser or owner (collectively, "Buyer"), that any product manufactured and sold by Connectrac will be substantially free from unreasonable and significant defects in material, construction, and workmanship under normal use, service, and only for their original purpose, for a period of five (5) years from the date of original installation or six (6) years from the date of purchase, whichever is sooner. Standard commercial tolerances apply. This Limited Warranty ("Statement") applies only to products, which have been installed properly in accordance with Installation Instructions supplied by Connectrac and any applicable codes and standards.

This Statement is void if any Connectrac products have been modified, repaired, altered, tampered, mixed with, or intermixed (used within a system) with products or materials in a manner not approved by Connectrac. This Statement does not cover Connectrac products subjected to accidents, improper use, improper maintenance, improper cleaning, negligence, misuse, or abuse. This Statement is void if damage results from the use of detergents, cleaners, abrasives, or other harsh chemical agents not authorized or sanctioned by Connectrac. Connectrac is in no way liable or responsible for any damage to Connectrac products that would void this Statement.

When you contact Connectrac, please provide reasonable proof of the date of your purchase of the Connectrac product at issue. It may be necessary for Connectrac to arrange an inspection of your product to determine whether or not a defect exists. Connectrac's sole obligation (and the sole exclusive remedy of the Buyer) with respect to any products that are proven to be defective, will, at the sole discretion of Connectrac, be the repair or replacement of the defective products or refund of the purchase price of the defective products. Returned products will not be accepted unless Connectrac is notified and authorizes the return, in writing, prior to shipment.

Certain products of Connectrac may have a specific limited warranty or limitation of liability included that differs from this Statement. The terms of any such specific limited warranty or limitation of liability supersede those set forth in this Statement.

Connectrac's products are listed by Underwriters Laboratories, Inc. and the Canadian Standards Association. Buyer agrees to exercise reasonable care in the installation and use of Connectrac products. Buyer acknowledges that Connectrac products may be dangerous and agrees to release Connectrac from any liability for injury or damage in connection therewith. Buyer further agrees to defend, indemnify, and hold harmless Connectrac from and against any and all third-party claims and liabilities (including, without limitation, reasonable attorneys' fees and costs), regardless of the form of action, arising out of or in connection with the installation and use of Connectrac products, provided that Buyer is notified promptly in writing of the action, Connectrac has not reached any compromise or settlement of such action or made any admissions in respect of the same, and Buyer is given the option, at its expense, to control the action and all requested reasonable assistance, including indemnification from any third party, to defend the same.

